

Pairs to 100 secret pictures

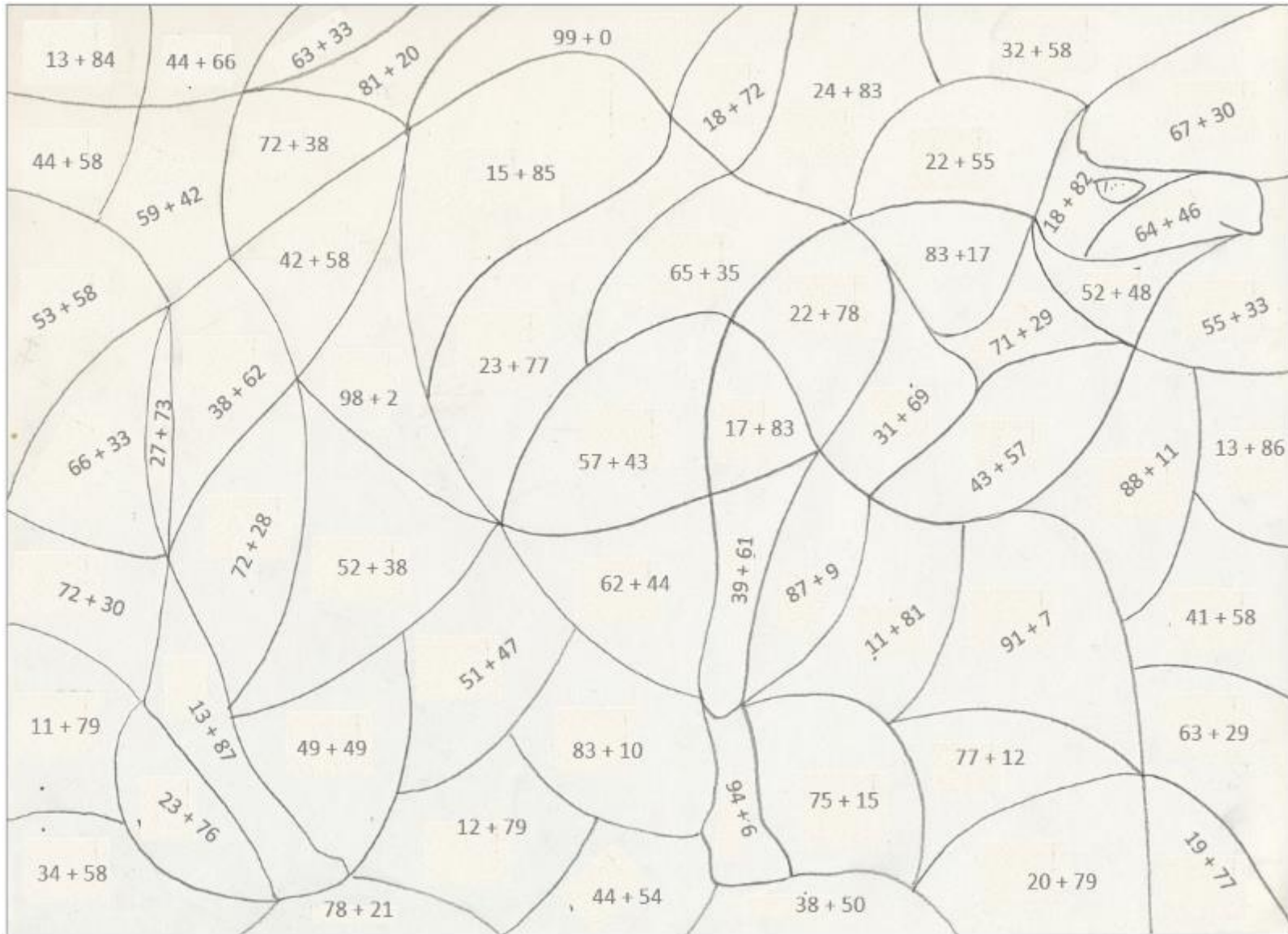

Pairs to 100 secret pictures



1-100 grid

1	2	3	4	5	6	7	8	9	10
11	12	13	14	15	16	17	18	19	20
21	22	23	24	25	26	27	28	29	30
31	32	33	34	35	36	37	38	39	40
41	42	43	44	45	46	47	48	49	50
51	52	53	54	55	56	57	58	59	60
61	62	63	64	65	66	67	68	69	70
71	72	73	74	75	76	77	78	79	80
81	82	83	84	85	86	87	88	89	90
91	92	93	94	95	96	97	98	99	100

Number cards

48

92

50

27

31

5

0.4

1.6

69

4.5

99

125

Making an open cube from cardboard

1. Cut a strip of card.



2. Fold it to create an open cube, then secure with masking tape.



3. Paint the outside.

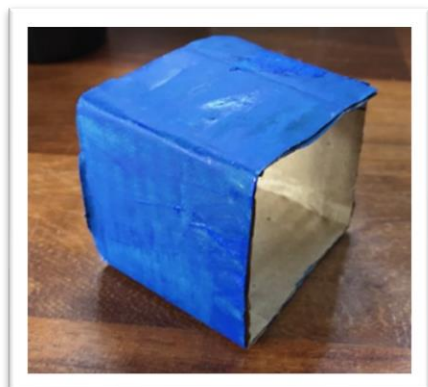

Cube net

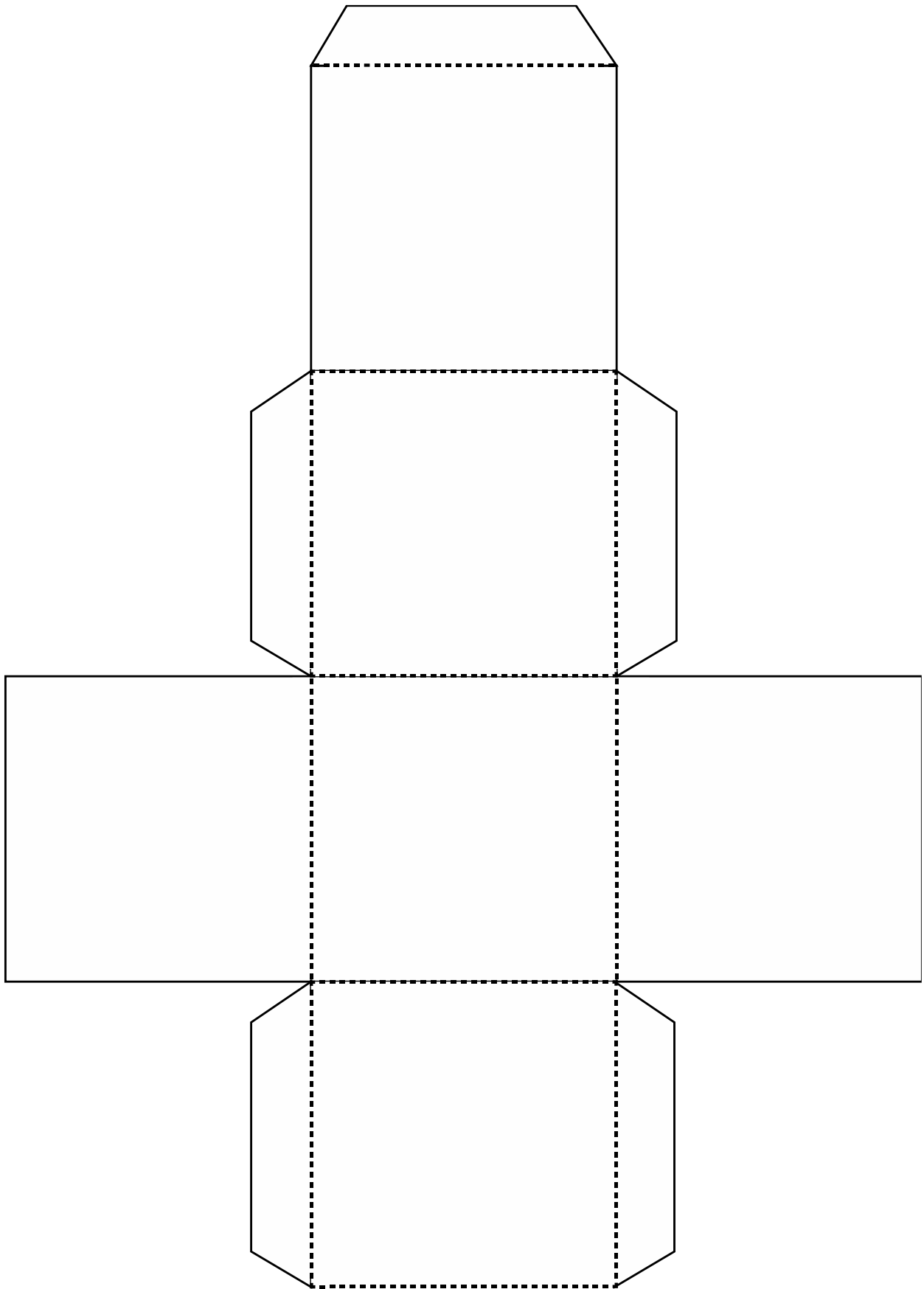

Cube nets

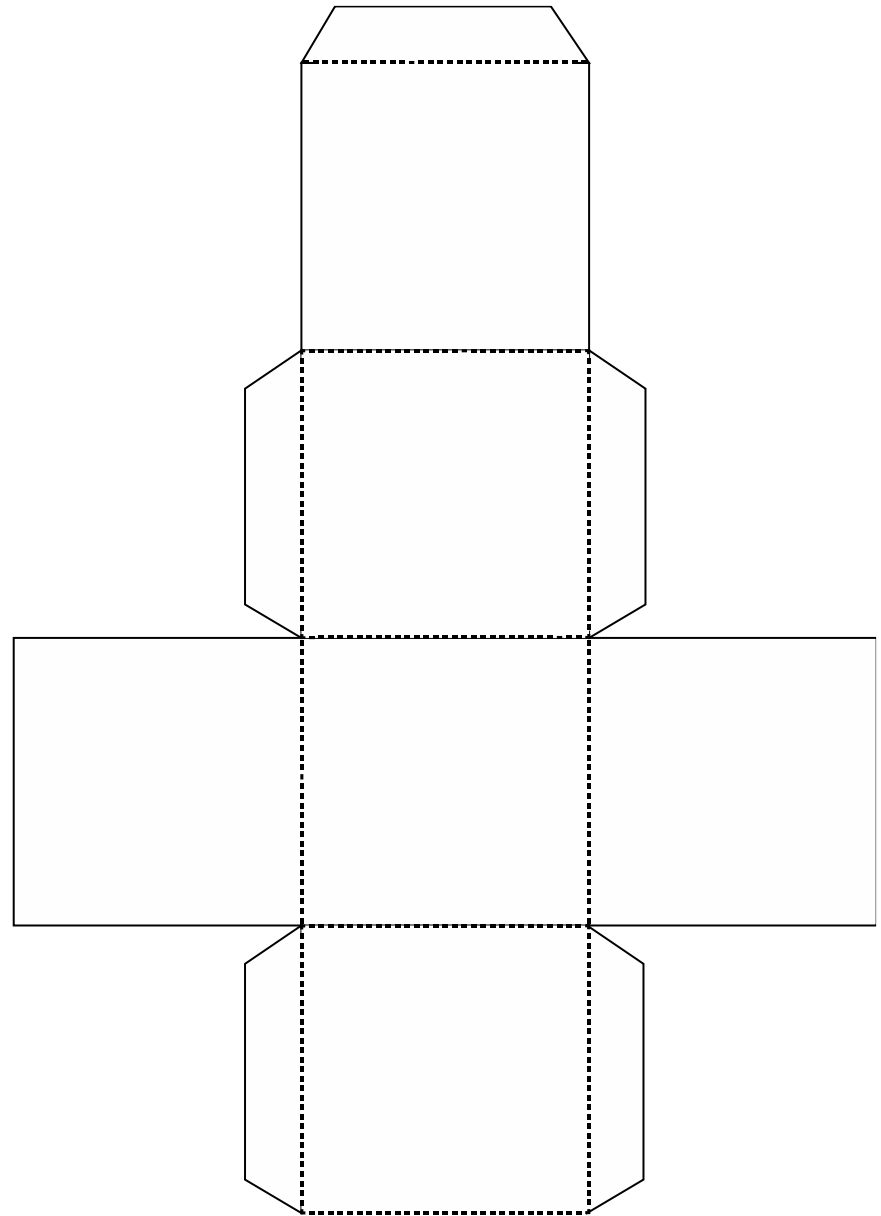
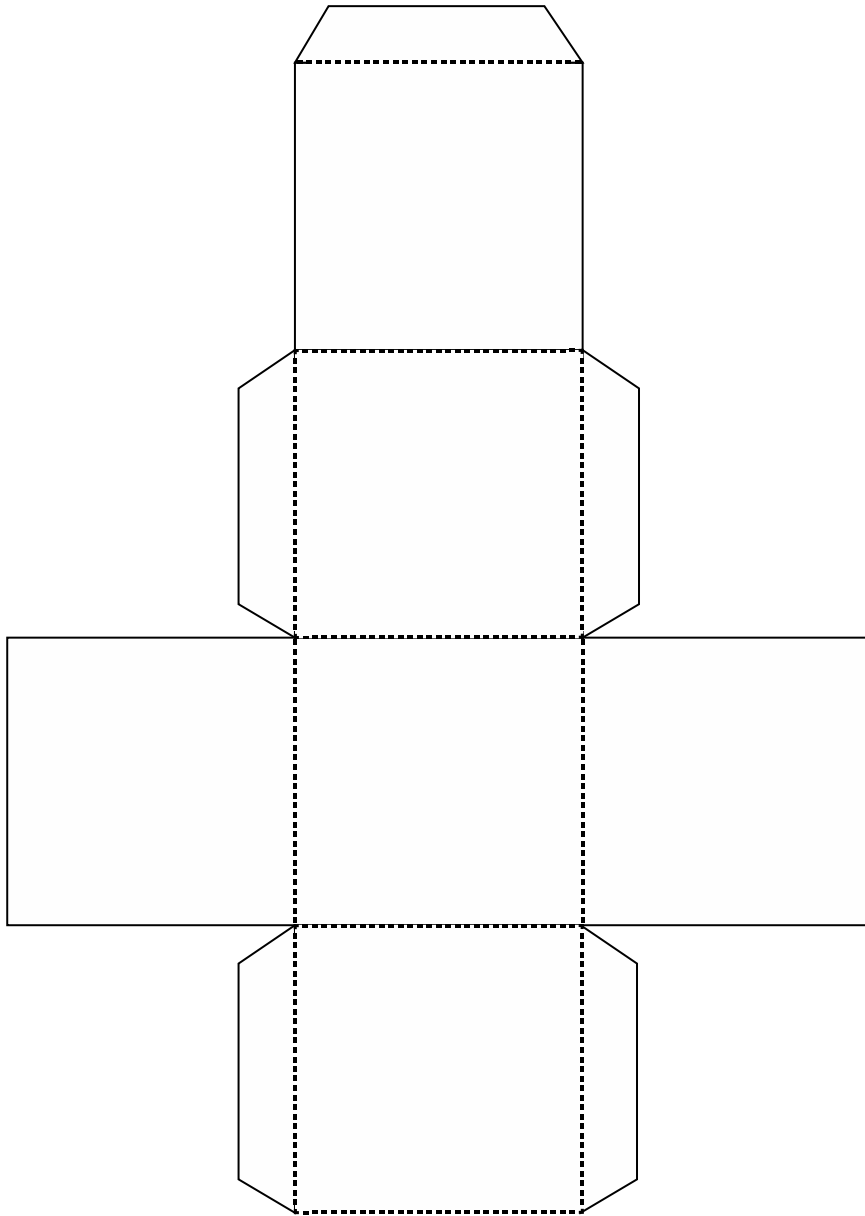

Cuboid nets

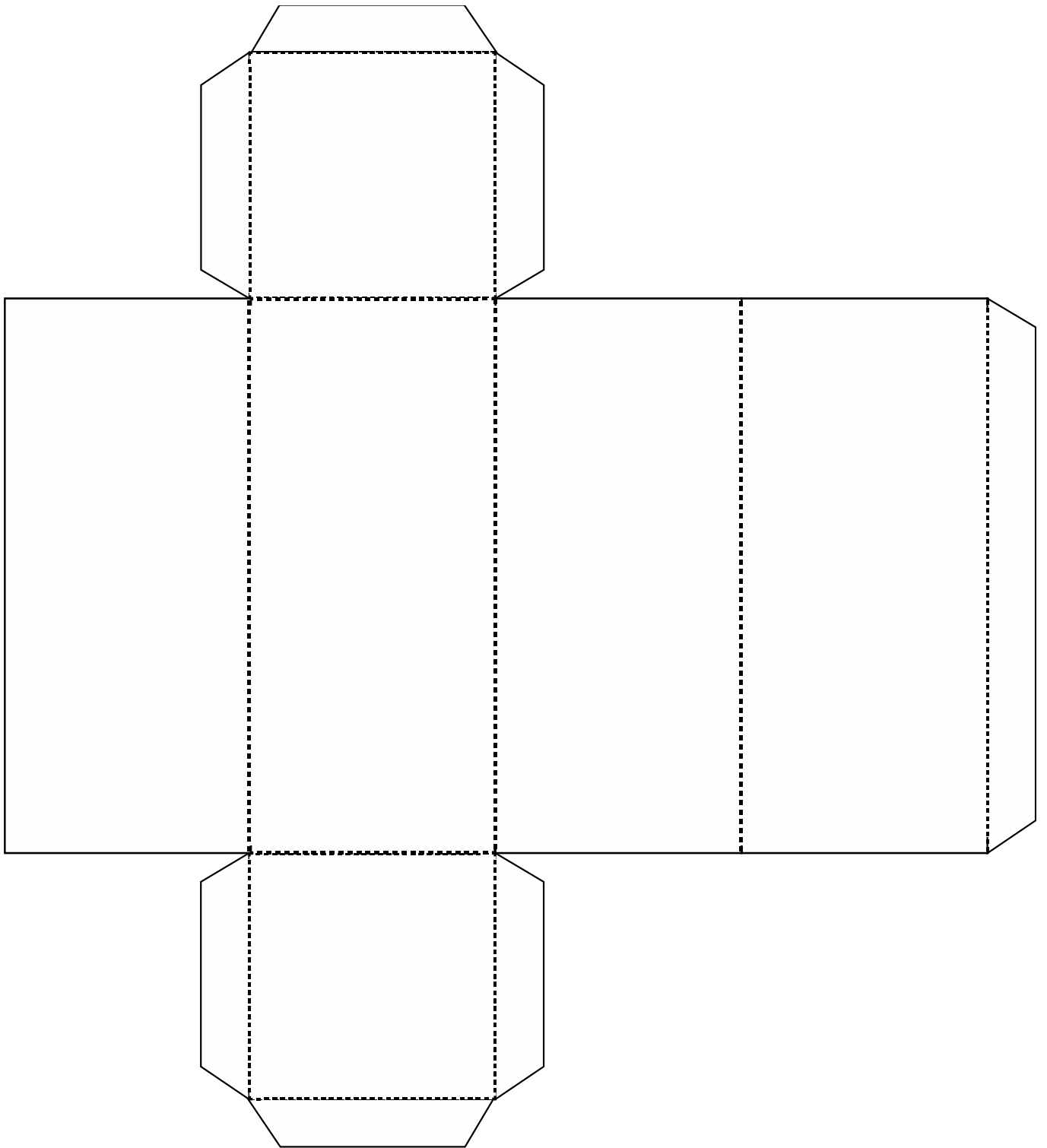

Cuboid nets

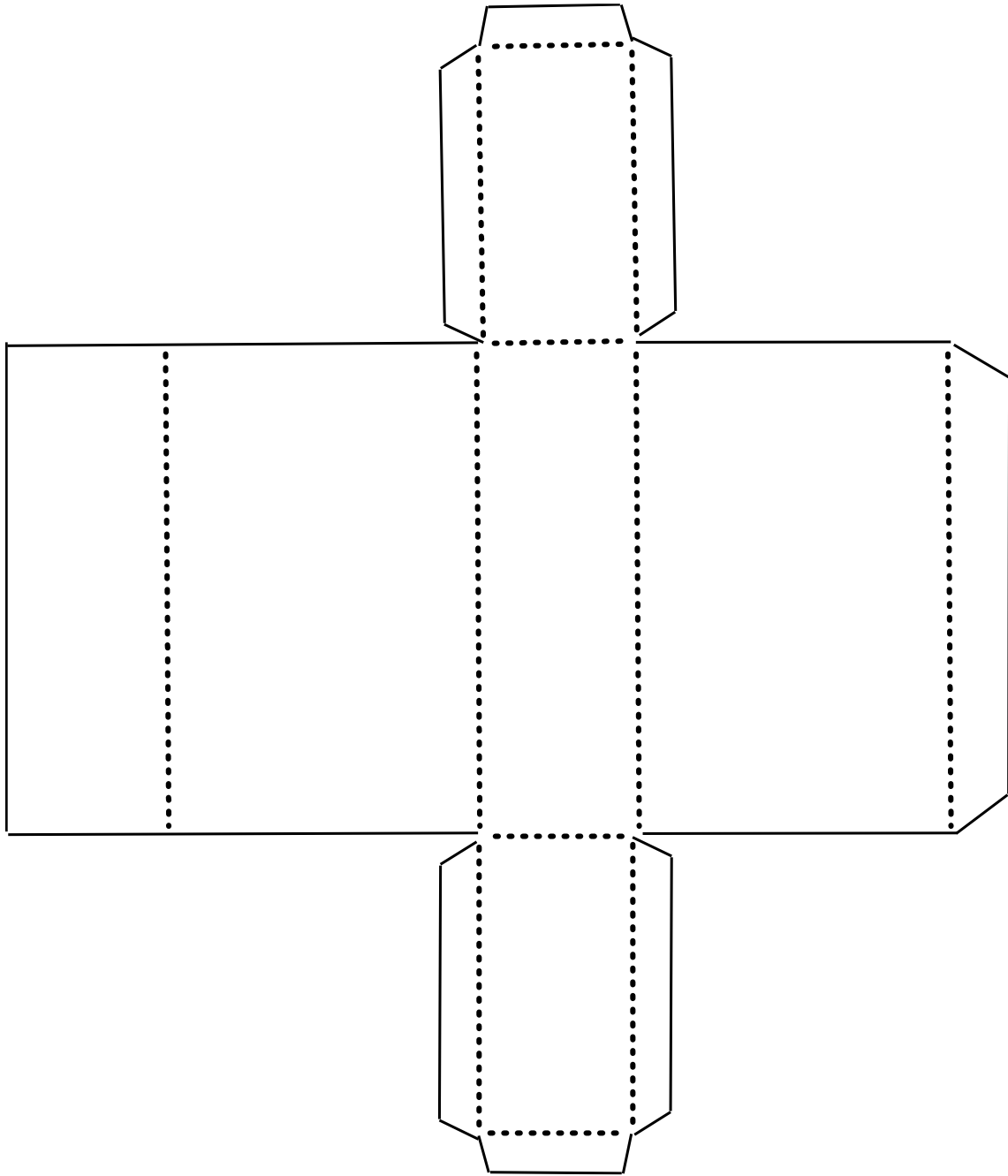

Cuboid nets

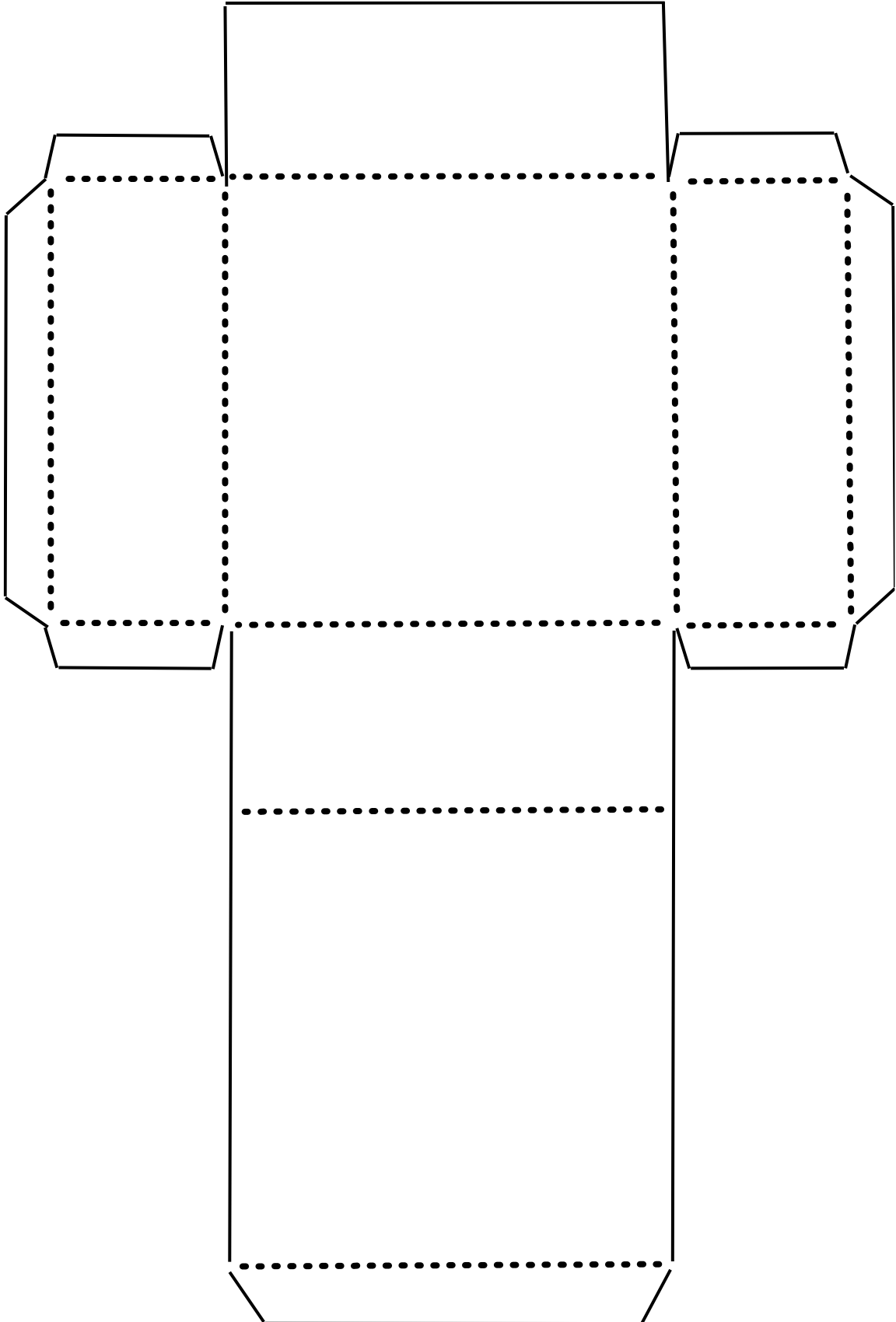



























Hieroglyph sounds

There are 25 monoliteral **hieroglyphs** (mono = one + literal = **sound**) in the Egyptian alphabet.

These represent the simplest written **sounds**.

They were used when it was necessary to spell things out, like names.

 A	 B	 C	 D	 E	 F
 G	 H	 I	 J	 K	 L
 M	 N	 O	 P	 Q	 R
 S	 T	 U	 V	 W	 X
 Y	 Z				

Hieroglyph symbols **Teacher information**



god



tadpole



finger



flower



rope



loop



line

1,000,000

100,000

10,000

1000

100

10

1

Hieroglyph number cards

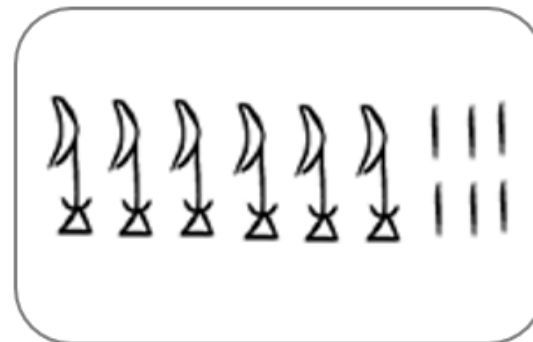
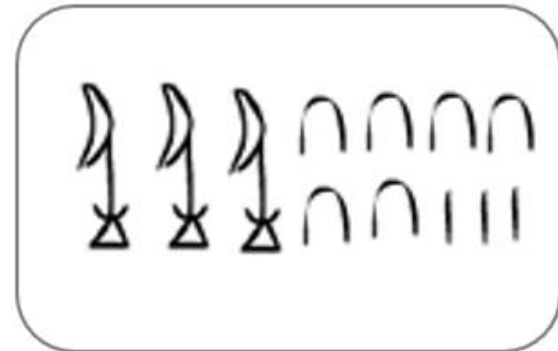
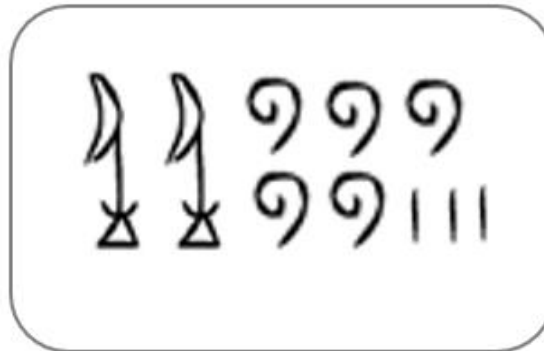
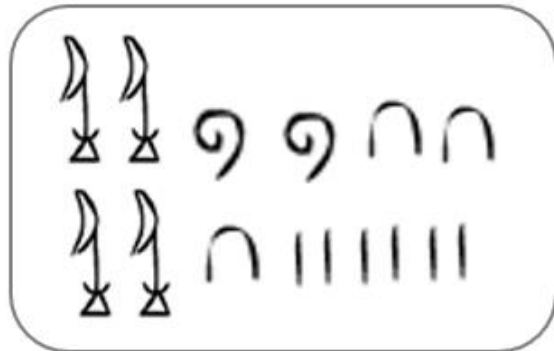
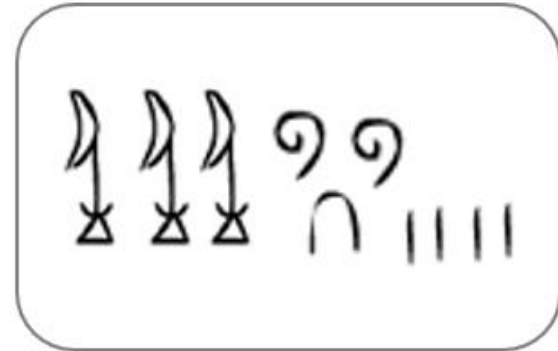
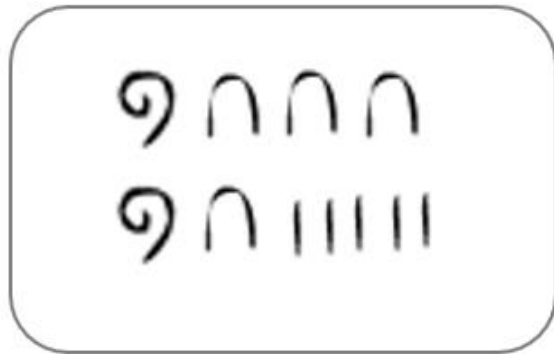

Tape-a shape Example



Tape-a shape

